



# GSM/GPRS/GPS Tracker **GV55LITE**

## User Manual

TRACGV55LITEUM001

Revision: 1.02



Document Title	GV55LITE User Manual
Version	1.02
Date	2012-11-08
Status	Release
Document Control ID	TRACGV55LITEUM001

### **General Notes**

Queclink offers this information as a service to its customers, to support application and engineering efforts that use the products designed by Queclink. The information provided is based upon requirements specifically provided to Queclink by the customers. Queclink has not undertaken any independent search for additional relevant information, including any information that may be in the customer's possession. Furthermore, system validation of this product designed by Queclink within a larger electronic system remains the responsibility of the customer or the customer's system integrator. All specifications supplied herein are subject to change.

### **Copyright**

This document contains proprietary technical information which is the property of Queclink Limited., copying of this document and giving it to others and the using or communication of the contents thereof, are forbidden without express authority. Offenders are liable to the payment of damages. All rights reserved in the event of grant of a patent or the registration of a utility model or design. All specification supplied herein are subject to change without notice at any time.

*Copyright © Shanghai Queclink Wireless Solutions Co., Ltd. 2012*

## Contents

1. Introduction.....	7
1.1. Reference.....	7
1.2. Terms and Abbreviations.....	7
2. Product Overview .....	8
2.1. Check Part List.....	8
2.2. Parts List.....	9
2.3. Interface Definition .....	9
2.4. GV55LITE User Cable Colour.....	10
3. Getting Started .....	11
3.1. Opening the Case .....	11
3.2. Closing the Case.....	11
3.3. Installing a SIM Card .....	12
3.4. Power Connection .....	12
3.5. Ignition Detection.....	13
3.6. Digital Inputs.....	13
3.7. Digital Outputs .....	14
3.8. Device Status LED .....	16

## Table Index

TABLE 1.	GV55LITE PROTOCOL REFERENCE .....	7
TABLE 2.	TERMS AND ABBREVIATIONS .....	7
TABLE 3.	PART LIST .....	9
TABLE 4.	DESCRIPTION OF 6 PIN CONNECTIONS.....	10
TABLE 5.	GV55LITE USER CABLE COLOUR DEFINITION.....	10
TABLE 6.	ELECTRICAL CHARACTERISTICS OF IGNITION DETECTION .....	13
TABLE 7.	ELECTRICAL CHARACTERISTICS OF THE DIGITAL INPUTS .....	13
TABLE 8.	ELECTRICAL CHARACTERISTICS OF DDIGITAL OUTPUTS .....	15
TABLE 9.	DEFINITION OF DEVICE STATUS AND LED .....	错误! 未定义书签。

## Figure Index

FIGURE 1.	APPEARANCE OF GV55LITE .....	8
FIGURE 2.	THE 6 PIN CONNECTOR ON THE GV55LITE .....	9
FIGURE 3.	OPENING THE CASE.....	11
FIGURE 4.	CLOSING THE CASE.....	11
FIGURE 5.	SIM CARD INSTALLATION.....	12
FIGURE 6.	TYPICAL POWER CONNECTION.....	12
FIGURE 7.	TYPICAL IGNITION DETECTION .....	13
FIGURE 8.	TYPICAL DIGITAL INPUT CONNECTION .....	14
FIGURE 9.	DIGITAL OUTPUT INTERNAL DRIVE CIRCUIT .....	14
FIGURE 10.	TYPICAL CONNECTION WITH RELAY .....	15
FIGURE 11.	TYPICAL CONNECTION WITH LED .....	15
FIGURE 12.	GV55LITE LED ON THE CASE .....	16

**Revision History**

Revision	Date	Author	Description of change
1.01	2012-7-31	Owen Feng	Initial
1.02	2012-11-08	Owen Feng	Change some pictures

## 1. Introduction

The GV55LITE is a powerful GPS locator designed for vehicle or asset tracking. It has superior receiver sensitivity, fast TTFF (Time to First Fix) and supports Dual-Band GSM frequencies 850/900/1800/1900, its location can be monitored in real time or be periodically tracked by a backend server or other specified terminals. The GV55LITE has multiple input/output interfaces that can be used for monitoring or controlling external devices. Based on the integrated @Track protocol, the GV55LITE can communicate with a backend server through the GPRS/GSM network to transfer reports of Emergency, geo-fence boundary crossings, low backup battery or scheduled GPS position as well as many other useful functions. Users can also use GV55LITE to monitor the status of a vehicle and control the vehicle by its external relay output. System Integrators can easily setup their tracking systems based on the full-featured @Track protocol.

### 1.1. Reference

**Table 1. GV55LITE Protocol Reference**

SN	Document name	Remark
[1]	GV55LITE @Track Air Interface Protocol	The air protocol interface between GV55LITE and backend server.

### 1.2. Terms and Abbreviations

**Table 2. Terms and Abbreviations**

Abbreviation	Description
AGND	Analog Ground
AIN	Analog Input
DIN	Digital Input
DOUT	Digital Output
GND	Ground
MIC	Microphone
RXD	Receive Data
TXD	Transmit Data
SPKN	Speaker Negative
SPKP	Speaker Positive

## 2. Product Overview

### 2.1. Check Part List



Before starting, check all the following items have been included with your GV55LITE. If anything is missing, please contact your supplier.



Figure 1. Appearance of GV55LITE

## 2.2. Parts List

Table 3. Part List

Name	Picture
GV55LITE Locator	63mm*50mm*13.2mm
User Cable	
DATA_CABLE_M (Optional)	

## 2.3. Interface Definition

The GV55LITE has a 6 PIN interface connector. It contains the connections for power, I/O. The sequence and definition of the 6PIN connector are shown in following figure:

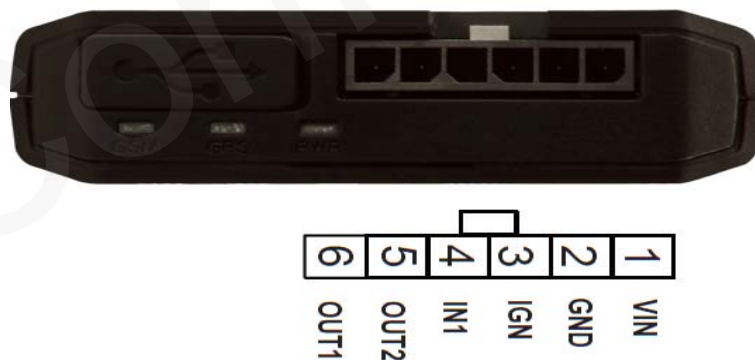



Figure 2. The 6 PIN connector on the GV55LITE

**Table 4. Description of 6 PIN Connections**

Index	Description	Comment
1	VIN	External DC power input, 8-32V
2	GND	GND
3	IGN	Ignition input, positive trigger
4	IN1	Digital input, negative trigger
5	OUT2	Open drain, 150mA max
6	OUT1	Open drain, 150mA max ,with latch circuit

## 2.4. GV55LITE User Cable Colour

**Table 5. GV55LITE User Cable Colour definition**

Definition	Color	PIN No.	Cable
VIN	Red	1	
GND	Black	2	
IGN	White	3	
IN1	Orange	4	
OUT2	Green	5	
OUT1	Blue	6	

## 3 . Getting Started

### 3.1. Opening the Case



**Figure 3. Opening the Case**

Insert the triangular-pry-opener into the gap of the case as shown below, push the opener up until the case unsnapped.

### 3.2. Closing the Case



**Figure 4. Closing the Case**

Place the cover on the bottom in the position as shown in the following figure. Slide the cover against the direction of the arrow until it snapped.

### 3.3. Installing a SIM Card

Open the case and ensure the unit is not powered (unplug the 6Pin cable). Slide the holder right to open the SIM card. Insert the SIM card into the holder as shown below with the gold-colored contact area facing down taking care to align the cut mark. Close the SIM card holder. Close the case.



Figure 5. SIM Card Installation

### 3.4. Power Connection

PWR (PIN1) / GND (PIN2) are the power input pins. The input voltage range for this device is from 8V to 32V. The device is designed to be installed in vehicles that operate on 12V or 24V systems without the need for external transformers.

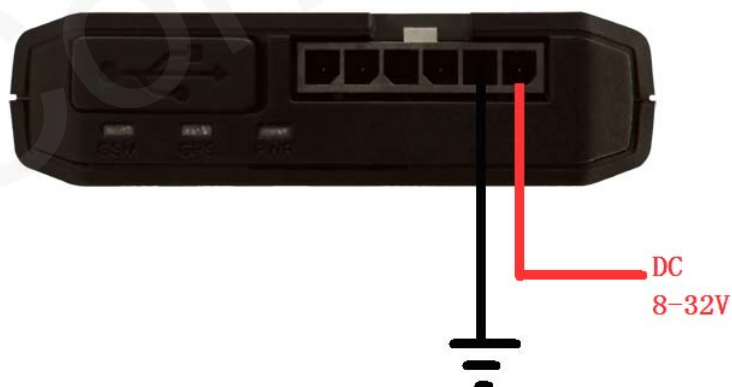

Figure 6. Typical Power Connection

### 3.5. Ignition Detection

**Table 6. Electrical Characteristics of Ignition Detection**

Logical State	Electrical State
Active	5.0V to 32V
Inactive	0V to 3V or Open



**Figure 7. Typical Ignition Detection**

IGN (Pin3) is used for ignition detection. It is strongly recommended to connect this pin to ignition key “RUN” position as shown up.

An alternative to connecting to the ignition switch is to find a non permanent power source that is only available when the vehicle is running. For example the power source for the FM radio.

IGN signal can be configured to start transmitting information to backend server when ignition is on; and enter power saving mode when ignition is off.

### 3.6. Digital Inputs

There are one general purpose digital inputs on GV55LITE. It is negative trigger.

**Table 7. Electrical Characteristics of the digital inputs**

Logical State	Electrical Characteristics
Active	0V to 0.8V
Inactive	Open

The following diagram shows the recommended connection of a digital input.

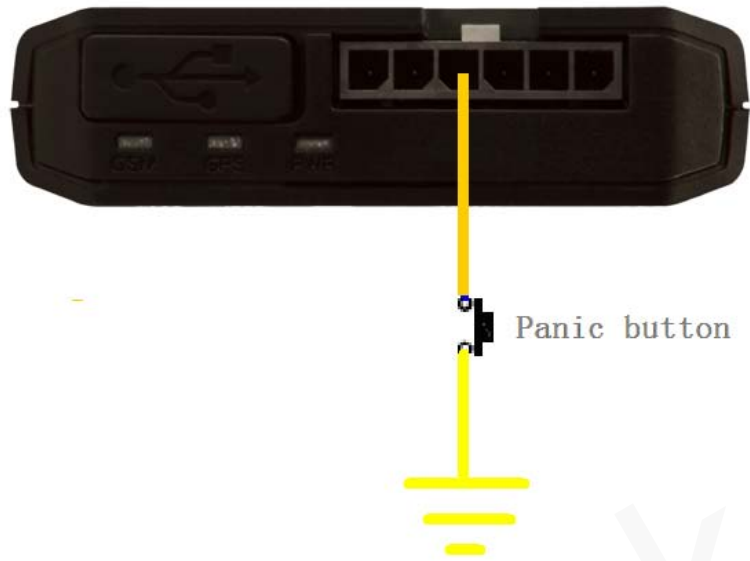

Figure 8. Typical Digital Input Connection

### 3.7. Digital Outputs

There are two digital outputs on GV55LITE. All are of open drain type and the maximum drain current is 150mA. Each output has the built-in over current and recovery PTC fuse

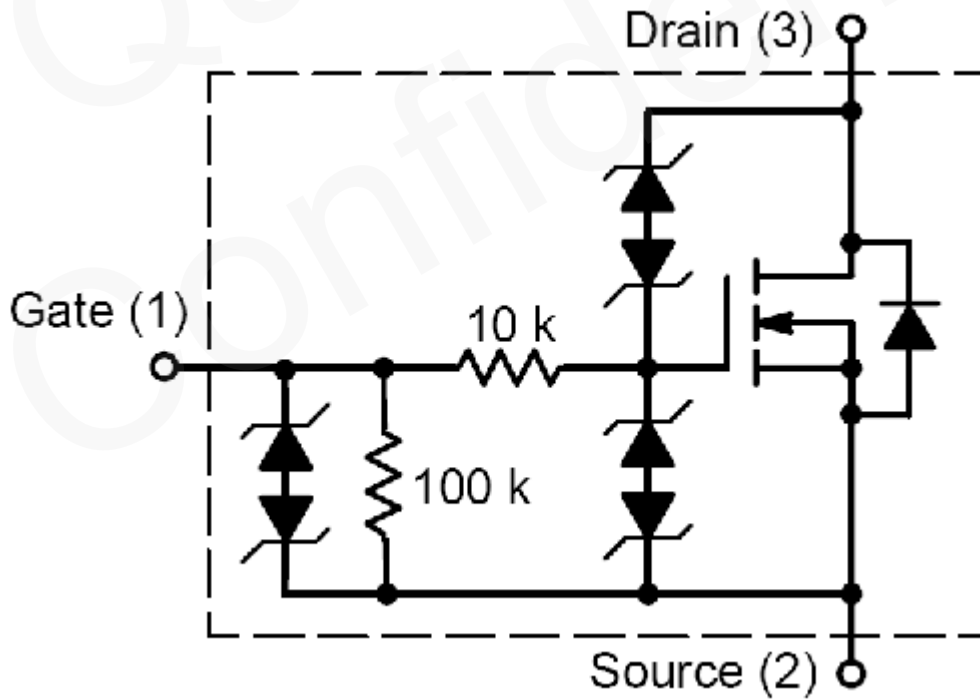
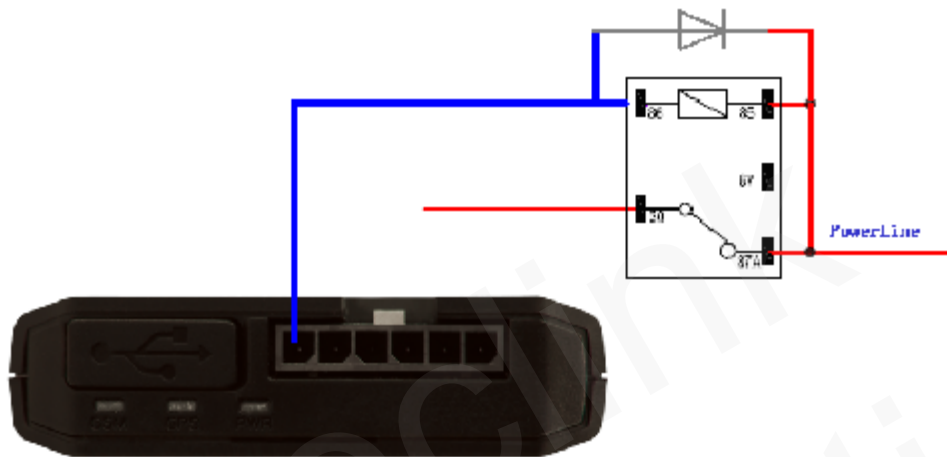
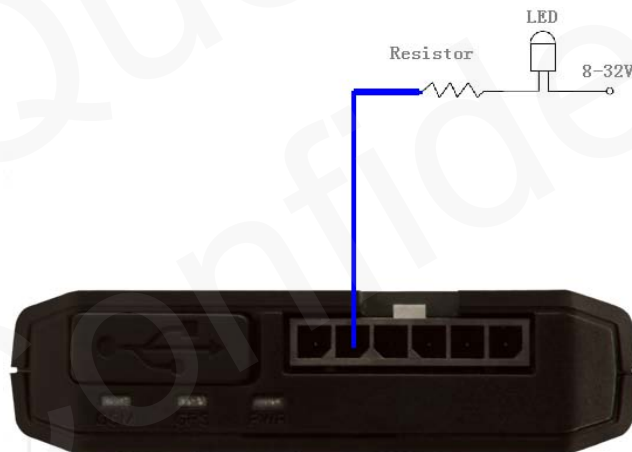

Figure 9. Digital Output Internal Drive Circuit

**Table 8. Electrical Characteristics of Digital Outputs**

Logical State	Electrical Characteristics
Enable	<1.5V @150mA
Disable	Open drain

**Figure 10. Typical Connection with Relay****Figure 11. Typical Connection with LED**

Note:

- 1 - OUT1 will latch the output state during reset.
- 2- All outputs are internally without pulled up to PWR pin by a diode. So an external flyback diode is needed when the output is connected to an inductive load.

### 3.8. Device Status LED

GSM (note1)	Device is searching GSM network	Fast flashing
	Device has registered to GSM network.	Slow flashing
	SIM card needs pin code to unlock.	ON
GPS (note 2)	GPS chip is powered off	OFF
	GPS sends no data or data format error	Slow flashing
	GPS chip is searching GPS info.	Fast flashing
	GPS chip has gotten GPS info.	ON
PWR (note 2)	No external power, and each time the device powers on, both LED's will work for 30 minutes and then are turned off deady when LED ON is 0	OFF
	External power in and LED ON is 1	ON

**Table 9. Definition of Device status and LED**

GV55LITE has three status led that GSM GPS PWR led.



**Figure 12. GV55LITE LED on the Case**

Note:

- 1 - GSM LED cannot be configured.
- 2 - GPS LED and PWR LED can be configured to turn off after a period of time using the configuration tool
- 3 - Fast flashing is about 60ms ON/ 780ms OFF
- 4 - Slow flashing is about 60ms ON/ 1940ms OFF
- 5 -When LED ON is 0, each time the device powers on, both LED's will work for 30 minutes and then are turned off deady